

## Surface Mount Isolators

Part Number: KTSI202S08-100

### Key Features

- Vibration Resistance, Shock Resistance
- Compact Structure, Small Size
- High Frequency Characteristic
- High Production Efficiency
- Operating Temperature Range: -40°C~+85°C
- Widely Used in All Kinds of Base Stations, Small Power Amplifier etc.

### Electrical Specifications at Room (25°C±5°C) Temperature

Part Number	Freq. Range (GHz)	Relative Bandwidth	Insertion Loss Max. (dB)	Isolation Min. (dB)	VSWR Max.	Load Power (W)	Connector Type
KTSI202S08-100	1.2 - 3.8	5%	0.4	23	1.20	100	SMD

### Mechanical Dimensions (mm)

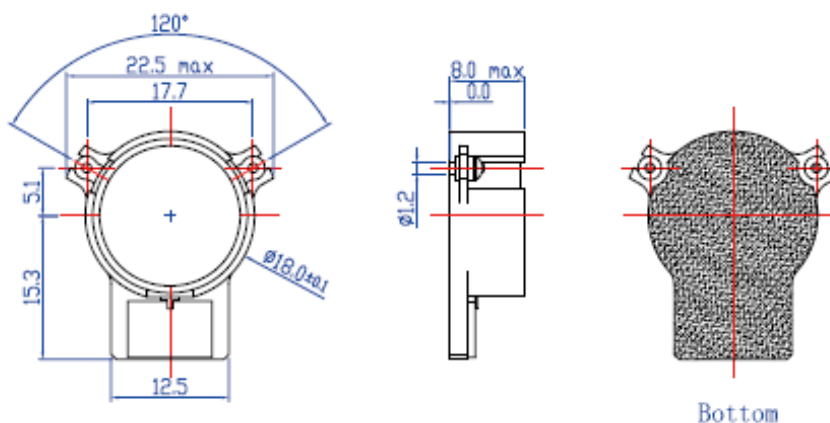

### HOW TO ORDER

