

Coaxial High Power Isolators

Part Number: KTCI0201A-B800

Key Features

- Frequency Range: 0.26 - 0.30GHz
- High Power Handling, Duty Ratio 30%
- Low Insertion Loss, High Isolation
- Wide Operating Temperature Range: -30°C~+70°C
- Commercial, Military and Space Applications

Electrical Specifications at Room (25°C±5°C) Temperature

Part Number	Freq. Range (GHz)	Bandwidth Max. (MHz)	Insertion Loss Max (dB)	Isolation Min. (dB)	VSWR Max.	Peak Power (W)	Duty Ratio	Reverse Power (W)	Connector Type
KTCI0201A-B800	0.26 - 0.30	full	0.4	20	1.25	2500	30%	800	N

Mechanical Dimensions (mm)

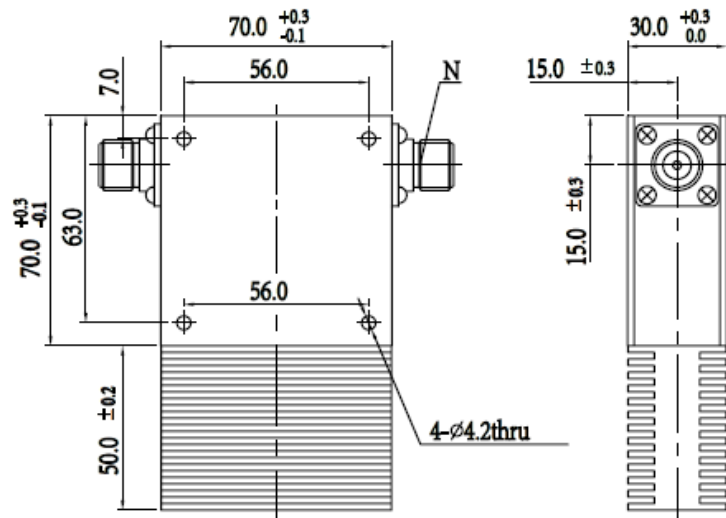

HOW TO ORDER

