

Drop-in Isolators

Part Number: KTDI102M4-10

Key Features

- Frequency Range: 1.2GHz - 3.8GHz
- Low Insertion Loss, High Isolation
- Small Size, Good Performance
- Wide Operating Temperature Range: -40°C~+85°C
- Commercial, Military and Space Applications

Electrical Specifications at Room (25°C±5°C) Temperature

Part Number	Freq. Range (GHz)	Bandwidth Max. (MHz)	Insertion Loss Max. (dB)	Isolation Min. (dB)	VSWR Max.	Reverse Power (W)	Connector Type
KTDI102M4-10	1.2 - 3.8	100	0.4	23	1.20	10	TAB

Mechanical Dimensions (mm)

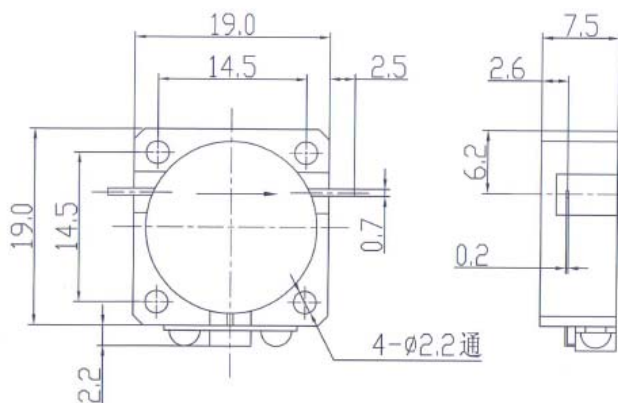

HOW TO ORDER

