

## Microstrip Circulator

Part Number: KTMC-502A3

### Key Features

- Frequency Range: 5.2GHz - 5.9GHz
- Good Consistency
- Small Size, High Precision
- High Isolation, Low Insertion Loss
- Wide Operating Temperature Range: -55°C~+85°C
- Widely Used in Various Millimeter Wave Radar & TR Components

### Electrical Specifications at Room (25°C±5°C) Temperature

Part Number	Freq. Range (GHz)	Bandwidth Max. (MHz)	Insertion Loss Max. (dB)	Isolation Min. (dB)	VSWR Max.	Connector Type
KTMC-502A3	5.2 - 5.9	full	0.5	18	1.30	GWB

### Mechanical Dimensions (mm)

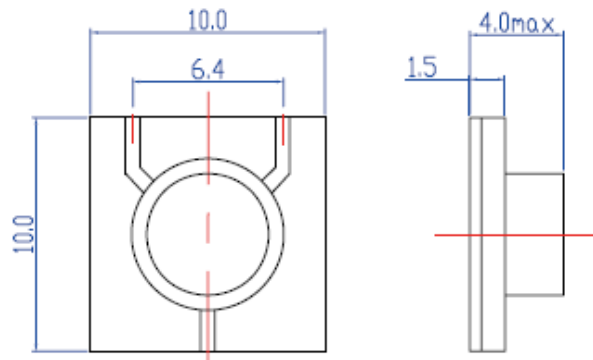

### HOW TO ORDER

