

Microstrip Dual Junction Circulator

Part Number: KTMC-502AS5

Key Features

- Frequency Range: 5.1GHz - 5.7GHz
- Good Consistency
- Small Size, High Precision
- High Isolation, Low Insertion Loss
- Wide Operating Temperature Range: -55°C~+85°C
- Widely Used in Various Millimeter Wave Radar & TR Components

Electrical Specifications at Room (25°C±5°C) Temperature

Part Number	Freq. Range (GHz)	Bandwidth Max. (MHz)	Insertion Loss Max. (dB)	Isolation Min. (dB)	VSWR Max.	Load Power (W)	Connector Type
KTMC-502AS5	5.1 - 5.7	full	0.5(2→3) 1.0(3→1)	20(3→2) 38(1→3)	1.3	10	GWB

Mechanical Dimensions (mm)

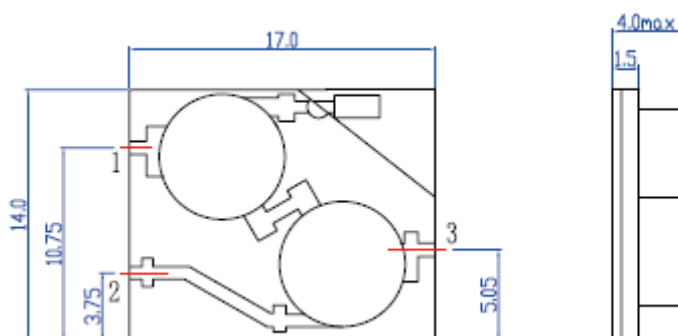

HOW TO ORDER

