

Microstrip Dual Junction Circulator

Part Number: KTMC-1202AS1

Key Features

- Frequency Range: 11.5GHz - 13.5GHz
- Good Consistency
- Small Size, High Precision
- High Isolation, Low Insertion Loss
- Wide Operating Temperature Range: -55°C~+85°C
- Widely Used in Various Millimeter Wave Radar & TR Components

Electrical Specifications at Room (25°C±5°C) Temperature

Part Number	Freq. Range (GHz)	Bandwidth Max. (MHz)	Insertion Loss Max. (dB)	Isolation Min. (dB)	VSWR Max.	Load Power (W)	Connector Type
KTMC-1202AS1	11.5 - 13.5	full	0.6(1→2) 1.1(2→3)	18(2→1) 30(3→2)	1.30	10	GWB

Mechanical Dimensions (mm)

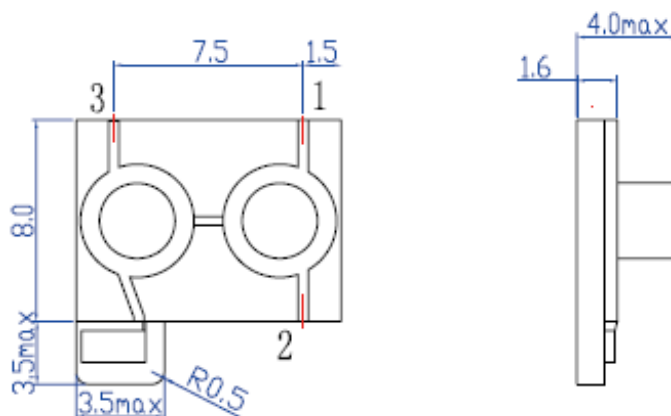

HOW TO ORDER

